

110N07

70V N-Channel MOSFET

Features:

- Low Intrinsic Capacitances.
- Excellent Switching Characteristics.
- Extended Safe Operating Area.
- Unrivalled Gate Charge : $Q_g = 35\text{ nC}$ (Typ.).
- $BV_{DSS} = 70\text{V}, I_D = 110\text{A}$
- $R_{DS(on)} : 8.6\text{ m}\Omega$ (Max) @ $V_G = 10\text{V}$
- 100% Avalanche Tested

TO-220

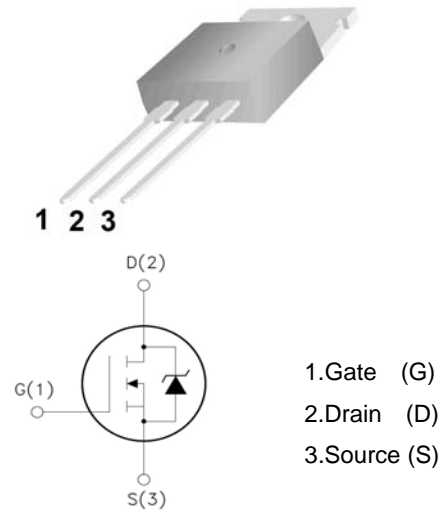

Absolute Maximum Ratings ($T_A = 25^\circ\text{C}$ unless otherwise noted)

Symbol	Parameter	Max.	Units
V_{DSS}	Drain-Source Voltage	70	V
V_{GSS}	Gate-Source Voltage	± 20	V
I_D	Continuous Drain Current	$T_C = 25^\circ\text{C}$	110
		$T_C = 100^\circ\text{C}$	92
I_{DM}	Pulsed Drain Current ^{note1}	340	A
EAS	Single Pulsed Avalanche Energy ^{note2}	121	mJ
P_D	Power Dissipation	$T_C = 25^\circ\text{C}$	116
$R_{\theta JC}$	Thermal Resistance, Junction to Case	0.85	$^\circ\text{C/W}$
T_J, T_{STG}	Operating and Storage Temperature Range	-55 to +175	$^\circ\text{C}$

Electrical Characteristics (TA=25°C unless otherwise noted)

Symbol	Parameter	Test Condition	Min.	Typ.	Max.	Units
Off Characteristic						
$V_{(BR)DSS}$	Drain-Source Breakdown Voltage	$V_{GS}=0V, I_D=250\mu A$	70	-	-	V
I_{DSS}	Zero Gate Voltage Drain Current	$V_{DS}=70V, V_{GS}=0V,$	-	-	1.0	μA
I_{GSS}	Gate to Body Leakage Current	$V_{DS}=0V, V_{GS}=\pm 20V$	-	-	± 100	nA
On Characteristics						
$V_{GS(th)}$	Gate Threshold Voltage	$V_{DS}=V_{GS}, I_D=250\mu A$	2	3	4	V
$R_{DS(on)}$	Static Drain-Source on-Resistance <small>note3</small>	$V_{GS}=10V, I_D=50A$	-	6.6	8.6	m Ω
Dynamic Characteristics						
C_{iss}	Input Capacitance	$V_{DS}=30V, V_{GS}=0V,$ $f=1.0MHz$	-	4062	-	pF
C_{oss}	Output Capacitance		-	261	-	pF
C_{rss}	Reverse Transfer Capacitance		-	231	-	pF
Q_g	Total Gate Charge	$V_{DS}=30V, I_D=50A,$ $V_{GS}=10V$	-	35	-	nC
Q_{gs}	Gate-Source Charge		-	11	-	nC
Q_{gd}	Gate-Drain("Miller") Charge		-	09	-	nC
Switching Characteristics						
$t_{d(on)}$	Turn-on Delay Time	$V_{DS}=30V, I_D=20A,$ $R_G=6.0\Omega, V_{GS}=10V$	-	9	-	ns
t_r	Turn-on Rise Time		-	7	-	ns
$t_{d(off)}$	Turn-off Delay Time		-	40	-	ns
t_f	Turn-off Fall Time		-	15	-	ns
Drain-Source Diode Characteristics and Maximum Ratings						
I_S	Maximum Continuous Drain to Source Diode Forward Current		-	-	85	A
I_{SM}	Maximum Pulsed Drain to Source Diode Forward Current		-	-	340	A
V_{SD}	Drain to Source Diode Forward Voltage	$V_{GS}=0V, I_S=50A$	-	-	1.2	V
t_{rr}	Body Diode Reverse Recovery Time	$I_F=20A, di/dt=100A/\mu s$	-	78	-	ns
Q_{rr}	Body Diode Reverse Recovery Charge		-	51	-	nC

Notes:1. Repetitive Rating: Pulse Width Limited by Maximum Junction Temperature

2. EAS condition : $T_J=25^\circ C, V_{DD}=30V, V_G=10V, L=0.5mH, R_g=25\Omega, I_{AS}=26A$

3. Pulse Test: Pulse Width $\leq 300\mu s$, Duty Cycle $\leq 0.5\%$

Typical Characteristics

Figure 1: Output Characteristics

Figure 2: Typical Transfer Characteristics

Figure 3: On-resistance vs. Drain Current

Figure 4: Body Diode Characteristics

Figure 5: Gate Charge Characteristics

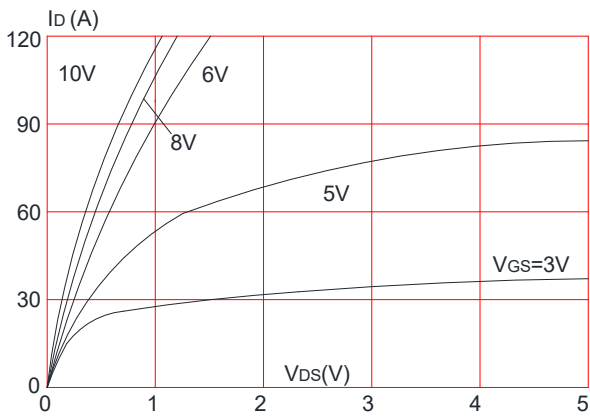
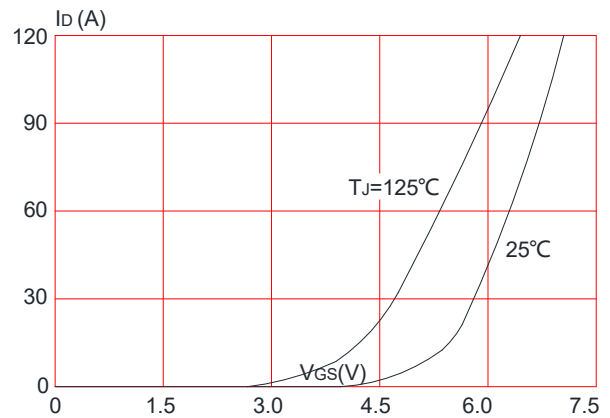
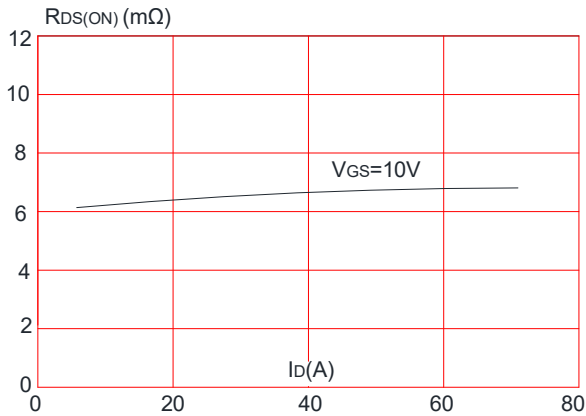
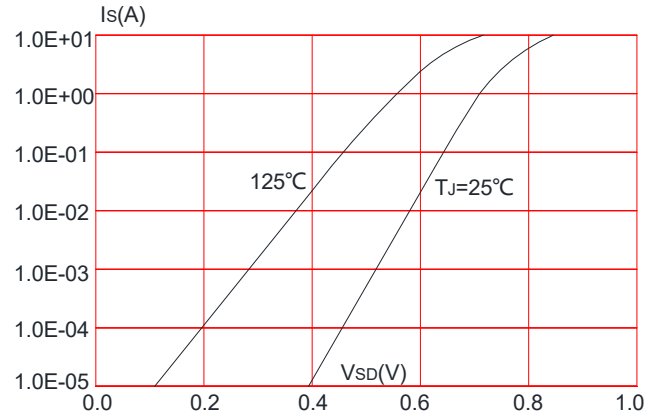
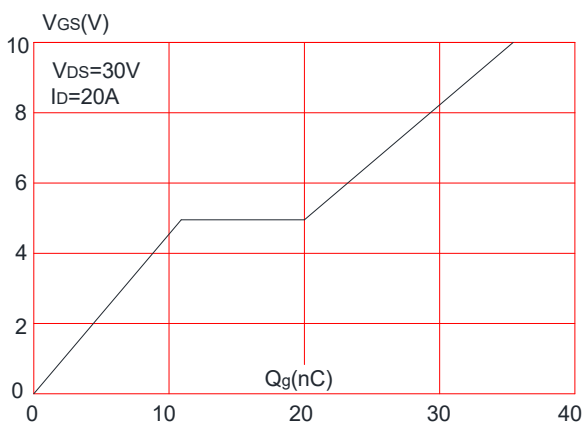
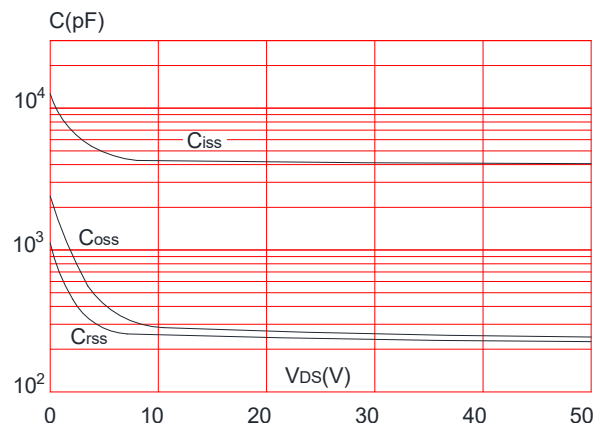
Figure 6: Capacitance Characteristics

Figure 7: Normalized Breakdown Voltage vs. Junction Temperature

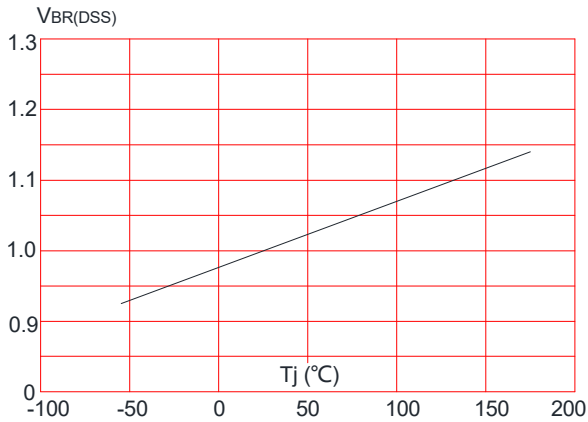

Figure 8: Normalized on Resistance vs. Junction Temperature

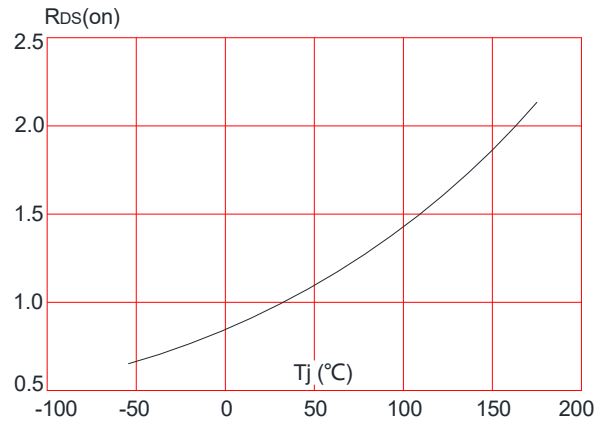

Figure 9: Maximum Safe Operating Area

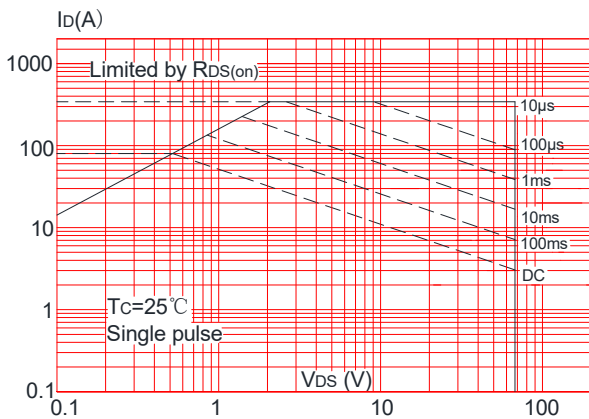

Figure 10: Maximum Continuous Drain Current vs. Case Temperature

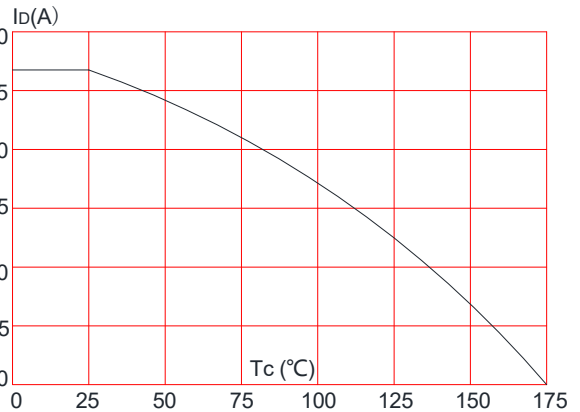
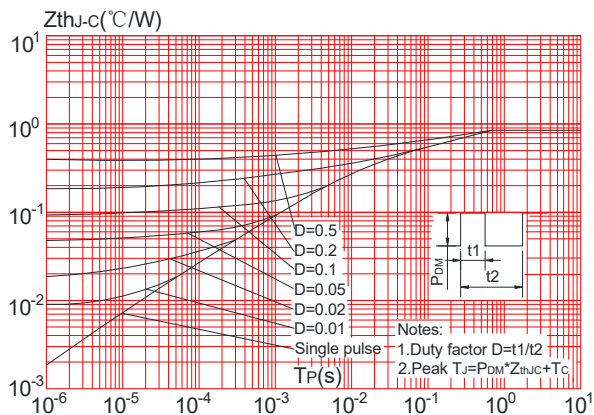

Figure.11: Maximum Effective Transient Thermal Impedance, Junction-to-Case



Test Circuit

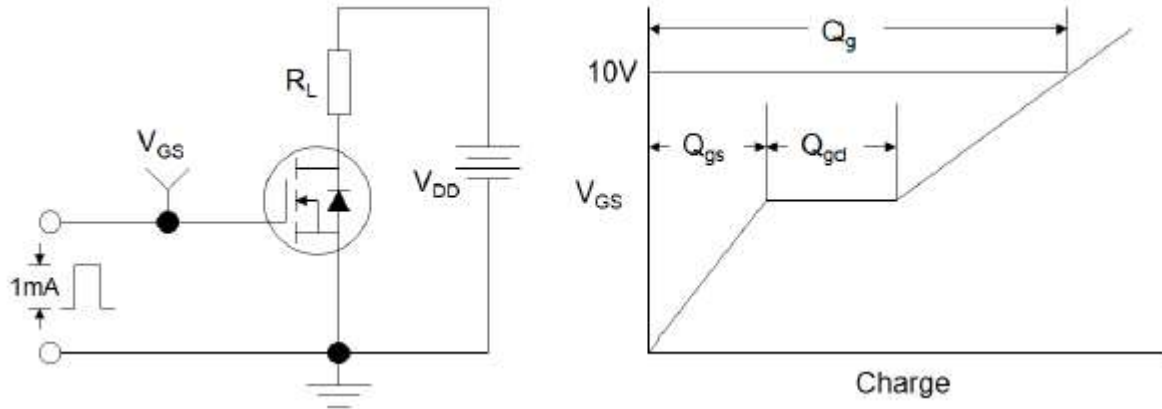

Figure1:Gate Charge Test Circuit & Waveform

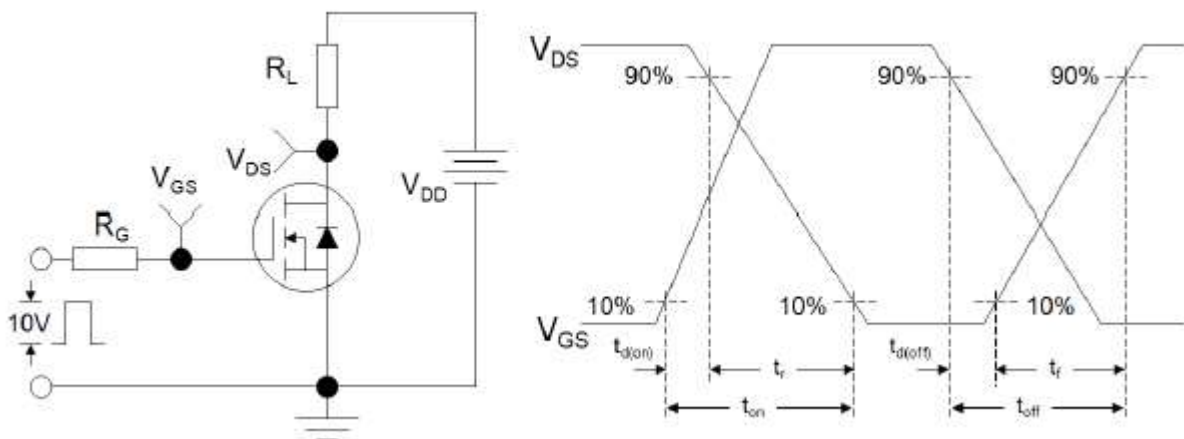

Figure 2: Resistive Switching Test Circuit & Waveforms

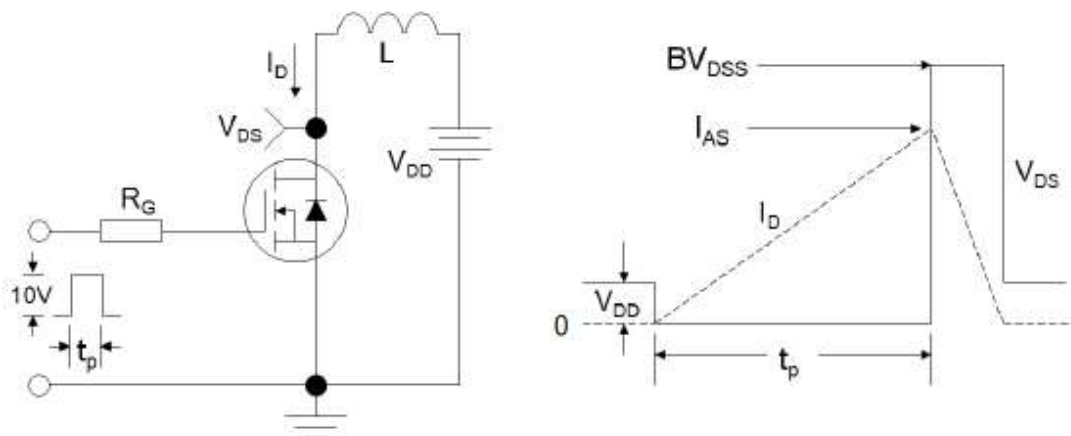
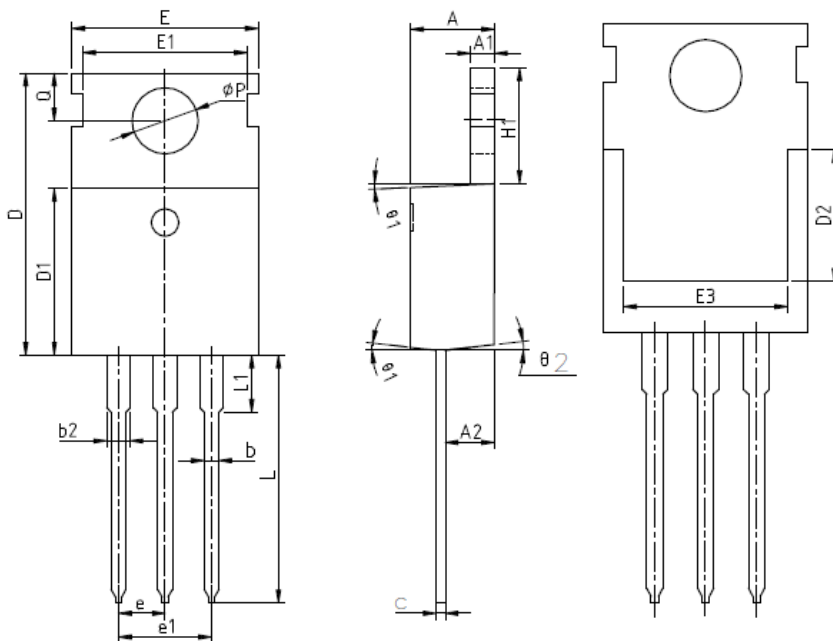

Figure 3:Unclamped Inductive Switching Test Circuit & Waveforms

Package Dimension
TO-220

SYMBOL	MIN	NOM	MAX
A	4.27	4.57	4.87
A1	1.15	1.30	1.45
A2	2.10	2.40	2.70
b	0.70	0.80	1.00
b2	1.17	1.27	1.50
c	0.40	0.50	0.65
D	15.10	15.60	16.10
D1	8.80	9.10	9.40
D2	5.70	6.70	7.00
E	9.70	10.00	10.30
E1	-	8.70	-
E2	9.65	10.00	10.35
E3	7.00	8.00	8.40
e	2.54		BSC
e1	5.08		BSC
H1	6.00	6.50	6.85
L	12.75	13.50	13.90
L1	-	3.10	3.40
ϕP	3.45	3.60	3.75
Q	2.60	2.80	3.00
$\theta 1$	4°	7°	10°
$\theta 2$	0°	3°	6°